



E SERIES VoIP SIP 2017 USER GUIDE

For E100IP, E100IPLBY, E100IPTRM, E200IP, E200IPTRM,
E103IP, E103IP RediDock, E203IP, E203IP RediDock

Table of Contents

E100IP Phone Map	3	3. Web Interface Settings	15
E103IP Phone Map	4	3.1 Home Page—Summary of Network Parameters	15
E200IP Phone Map	5	3.2 Network Settings	16
E203IP Phone Map	6	3.2.1 WAN Settings	16
E103IP & E203IP RediDock Phone Map	7	3.2.2 Basic Settings.	16
E100IP & E200IP Trimline Phone Map	8	3.2.3 DHCP.	16
Quick Start	9	3.2.4 Static IP Settings	16
Function	9	3.2.5 PPPoE Settings (Point to Point Protocol over Ethernet)	16
Standards and Protocols.	10	3.2.6 802.1X Settings.	16
1. Introduction	10	3.2.7 LLDP Settings	17
1.1 Overview of Hardware.	10	3.2.8 LAN Settings.	17
1.1.1 Base Unit	10	3.3 VoIP Settings	17
1.1.2 DECT Handset	10	3.3.1 Primary Register	17
1.2 Overview of Software	11	3.3.2 Audio Settings	18
1.2.1 Configuration Methods	11	3.3.3 Call Features	19
1.2.2 Specs Overview	11	3.3.4 Dialing Rules	20
1.3 Understanding Buttons and Hardware.	11	3.3.5 Multicast Paging	21
2. Operating Method for Dialing	13	3.3.6 Advanced Settings	21
2.1 How to Dial a Phone	13	3.4 QoS Settings (Quality of Service)/ Virtual LAN (VLAN)	22
2.1.1 Basic Call	13	3.5 Provisioning	22
2.1.2 Hold and Resume.	13	3.5.1 Provisioning Options	22
2.1.3 Volume Control.	14	3.5.2 Provisioning Server Settings.	23
2.1.4 Mute	14	3.5.3 AutoUpdate Settings	23
2.1.5 Multi-Function Memory Keys	14	3.5.4 WebUI Management.	24
2.1.6 Three-Way Conversation.	14	3.6 System Settings.	24
2.1.7 Transfer	14	3.6.1 Logging Server.	24
2.1.8 Call Park.	14	3.6.2 Time Settings	24
2.1.9 Redial	14	3.6.3 User Management	25
2.1.10 Register Handset	14	3.6.4 System Actions.	25
2.1.11 Delete Handset.	15	3.6.5 DECT—Digital Enhanced Cordless Telecommunications.	25
2.1.12 Switch between Base and Handset	15	4. Tech Notes	26
2.1.13 Switch between Line 1 and Line 2	15	4.1 LLDP—Tech Notes	26
2.1.14 Base Phone and Cordless Handset Can Maintain Independent Conversations	15	4.2 802.1x—Tech Notes.	27
		4.3 DHCP Options—Tech Notes	27
		4.4 QuickKey DialPad Shortcuts.	28
		Important Safety Instructions.	30

E100IP Phone Map

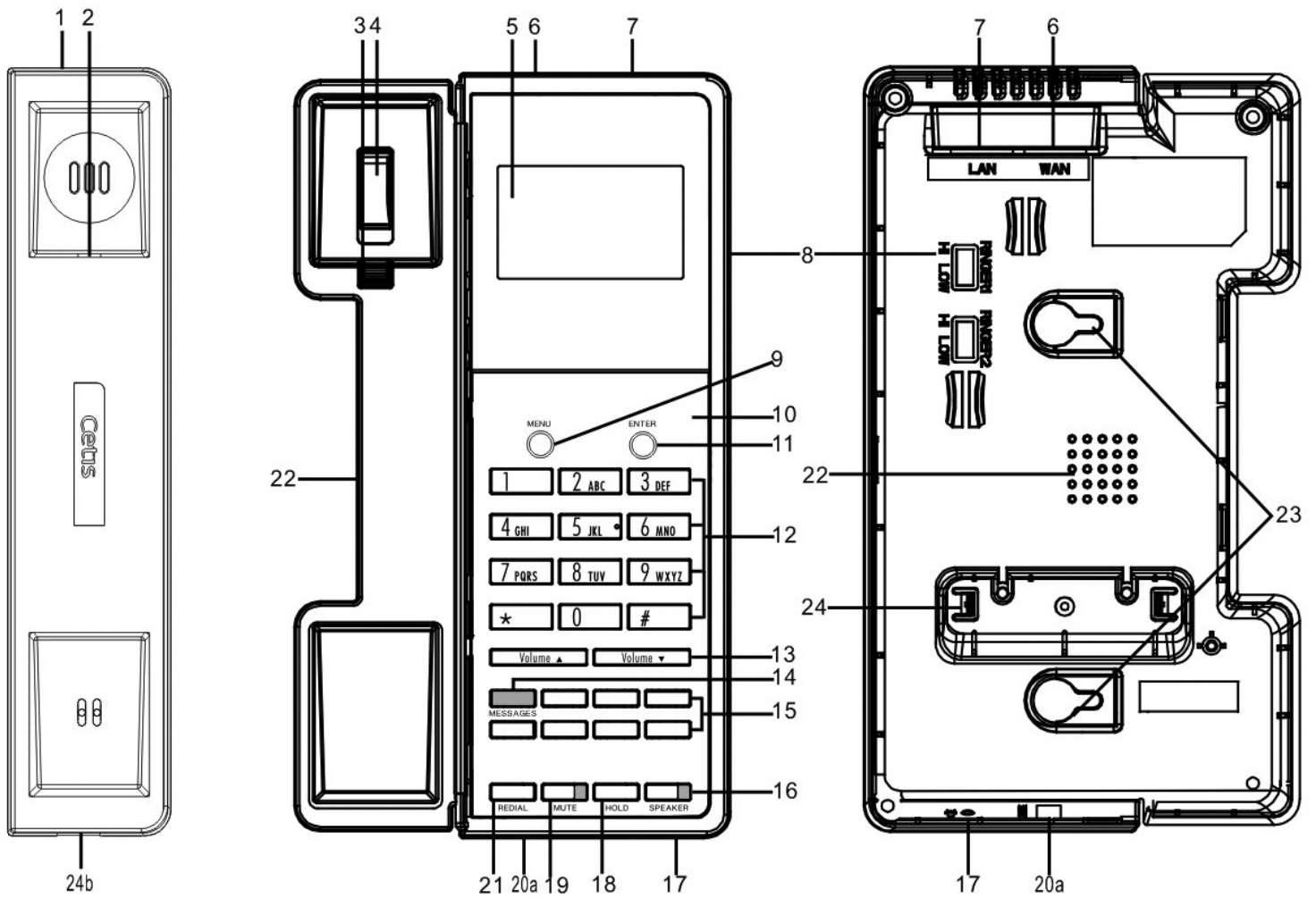

BASE FEATURES AND CONTROLS

- | | |
|-------------------------------------|--|
| 1. Handset | 13. Volume s (increase) and Volume t (decrease) keys |
| 2. Wall mount clip slot | 14. Message Waiting Indicator (MWI) light |
| 3. Wall mount handset clip | 15. 4, 8, 12, or 0 Memory keys |
| 4. Actuator for hookswitch | 16. Speaker key |
| 5. LCD display | 17. Microphone |
| 6. RJ-45 WAN input (POE) | 18. Hold key |
| 7. RJ-45 LAN input | 19. Mute key |
| 8. Ringer volume switch (unused) | 20. a/b. Handset coil cord receptacles |
| 9. Not applicable | 21. Redial key |
| 10. Paper faceplate/Plastic overlay | 22. Speaker—half duplex |
| 11. Enter key (submerged) (unused) | 23. Wall mount bracket |
| 12. Dialpad | 24. Desk mount bracket |

E103IP Phone Map

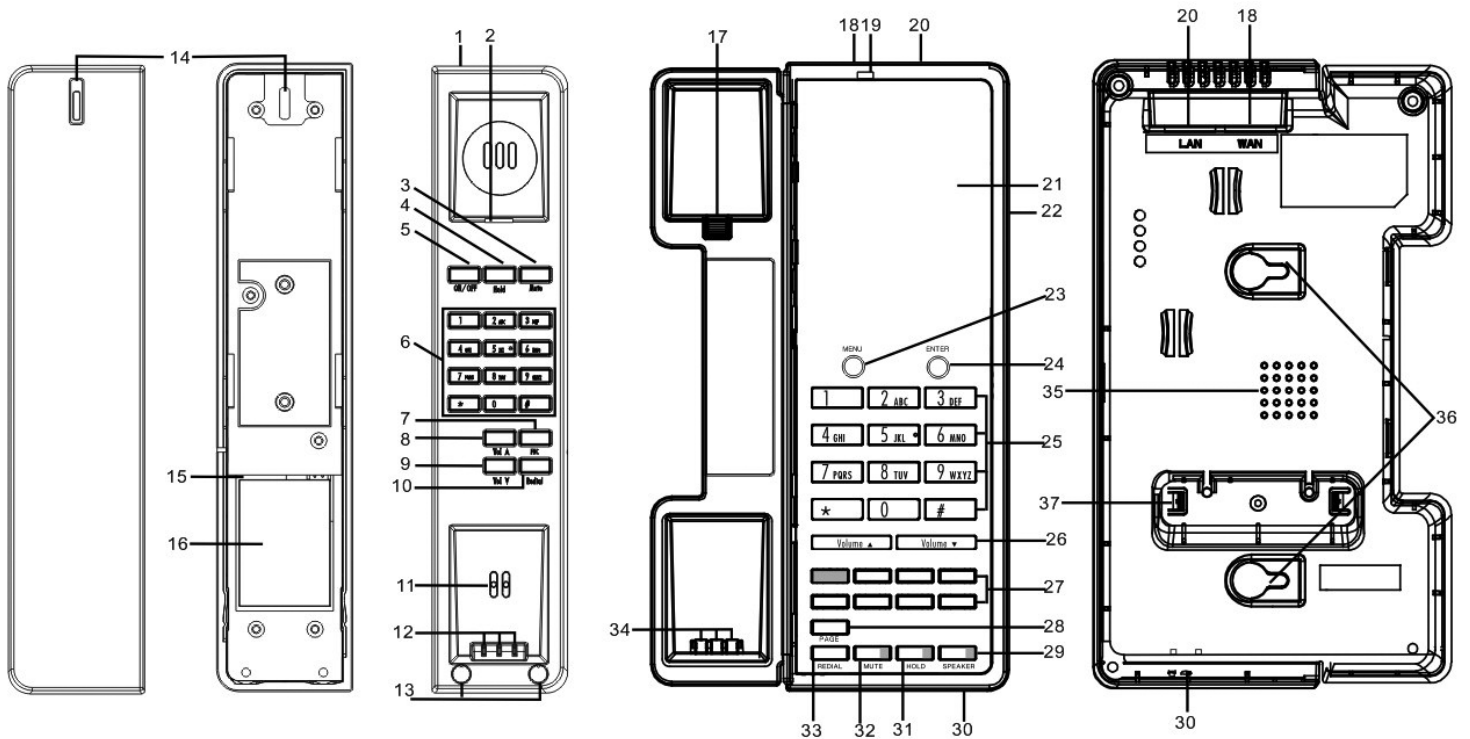

BASE FEATURES AND CONTROLS

- | | |
|---|--|
| <ol style="list-style-type: none"> 1. Handset 2. Wall mount clip slot 3. Mute key 4. Hold key 5. On/Off key 6. Handset dialpad 7. FNC key (handset) 8. Handset volume s (increase) 9. Handset volume t (decrease) 10. Redial key (handset) 11. Microphone (handset) 12. Charging leads (handset) 13. Screws and rubber plugs for handset cover and battery access (in separate bag) 14. Handset Message Waiting/Ringing Indicator/Speaker key 15. Battery tray (handset) 16. Battery (handset) 17. Wall mount handset clip 18. RJ-45 WAN (POE) input for power and network connection | <ol style="list-style-type: none"> 19. LED charging indicator 20. RJ-45 LAN input for guest connectivity 21. Faceplate and plastic overlay 22. Phone case 23. Not applicable 24. Enter key (submerged) (unused) 25. Dial pad 26. Volume s and Volume t keys 27. 4, 8, 12, or 0 memory keys (shaded key is OneTouch message retrieval key) 28. Page key 29. Speaker key 30. Microphone (base) 31. Hold key (base) 32. Mute key (base) 33. Redial key (base) 34. Charging leads (base) 35. Speaker—half duplex (base) 36. Wall mount bracket 37. Desk mount bracket |
|---|--|

E200IP Phone Map

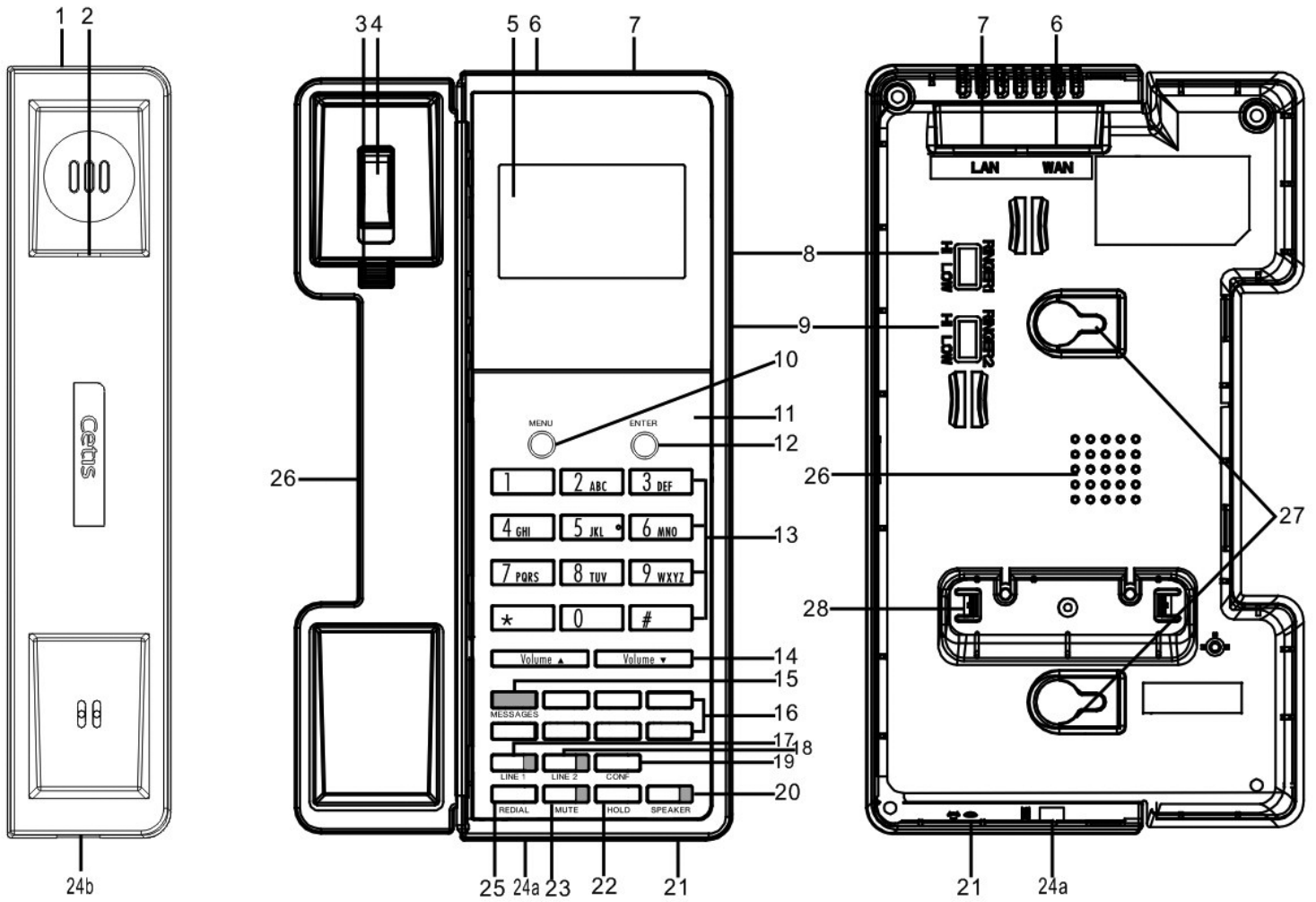

BASE FEATURES AND CONTROLS

- | | |
|---|--|
| 1. Handset | 15. OneTouch message retrieval key |
| 2. Wall mount clip slot | 16. 4, 8, 12, or 0 Memory keys |
| 3. Wall mount handset clip | 17. Line 1 key |
| 4. Actuator for hookswitch | 18. Line 2 key |
| 5. LCD display for MWI and interface | 19. Conference key |
| 6. RJ-45 WAN input (POE) for voice network connectivity | 20. Speaker key |
| 7. RJ-45 LAN Input for guest connectivity | 21. Microphone |
| 8. Ringer volume switch (unused) | 22. Hold key |
| 9. Ringer Hi/Low (unused in VoIP) | 23. Mute key |
| 10. Not applicable | 24. a/b. Handset coil cord receptacles |
| 11. Paper faceplate/Plastic overlay | 25. Redial key |
| 12. Enter key (submerged) | 26. Speaker—half duplex |
| 13. Dialpad | 27. Wall mount bracket |
| 14. Volume s (increase) and Volume t (decrease) keys | 28. Desk mount bracket |

E203IP Phone Map

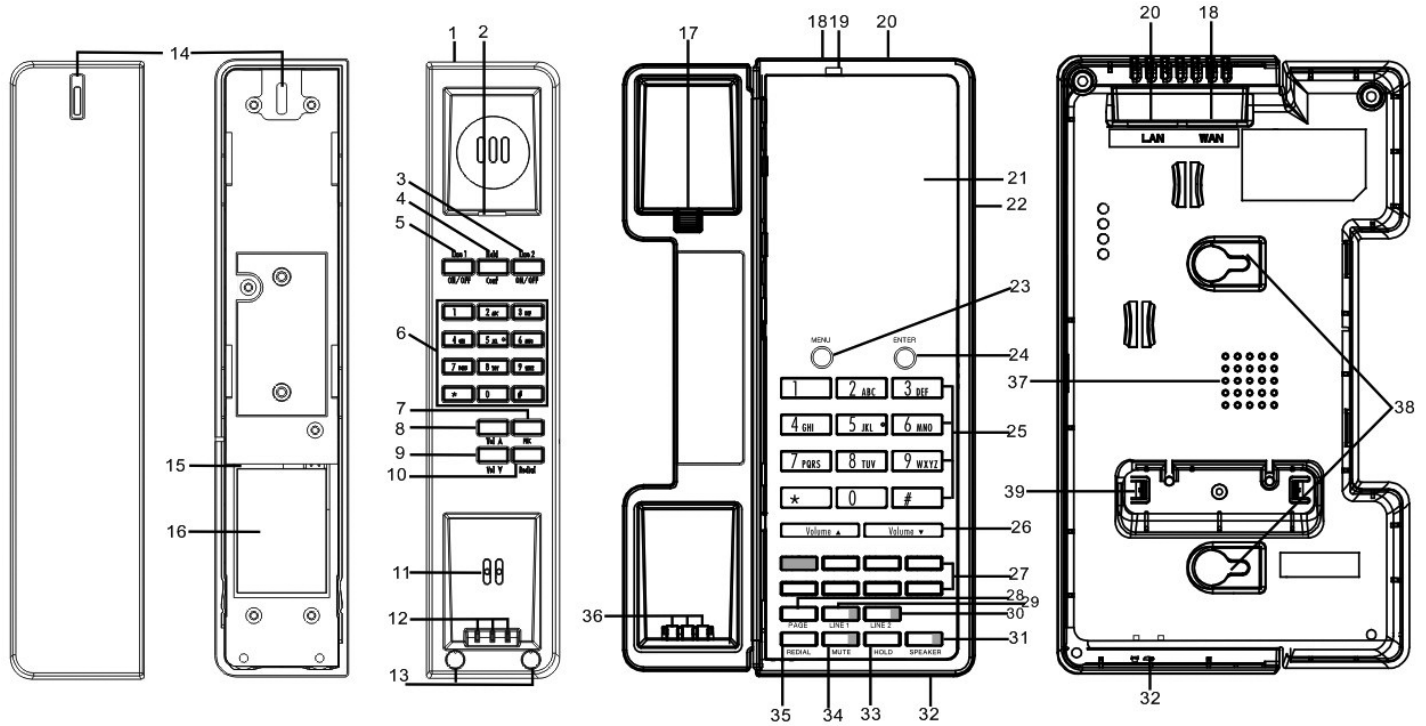

BASE FEATURES AND CONTROLS

- | | |
|--|---|
| <ol style="list-style-type: none"> 1. Cordless handset 2. Wall mount clip slot 3. Line 2 On/Off key 4. Hold/Conf key 5. Line 1 On/Off key 6. Handset dialpad 7. FNC key (handset) 8. Handset Volume s (increase) 9. Handset Volume t (decrease) 10. Redial key (handset) 11. Microphone (handset) 12. Charging leads (handset) 13. Screws for battery access 14. Message waiting/Ringing indicator (handset) 15. Battery tray (handset) 16. Battery (handset) 17. Wall mount handset clip 18. RJ-45 WAN input (POE) for power and voice network connectivity 19. Handset message waiting/Ringing indicator (base) 20. RJ-45 LAN input for guest connectivity | <ol style="list-style-type: none"> 21. Paper faceplate/Plastic overlay 22. Phone case 23. Not applicable 24. Enter key (submerged) (unused) 25. Dial pad 26. Volume s (increase) and Volume t (decrease) keys 27. 4, 8, 12, or 0 Memory keys (shaded key is programmable OneTouch message retrieval key) 28. Page key 29. Line 1 key 30. Line 2 key 31. Speaker key 32. Microphone (base) 33. Hold Key (base) 34. Mute key (base) 35. Redial key (base) 36. Charging leads (base) 37. Speaker—half duplex (base) 38. Wall mount bracket 39. Desk mount bracket |
|--|---|

E103IP & E203IP RediDock Phone Map



BASE FEATURES AND CONTROLS

1. Cordless handset
2. Base for charging cordless handset
3. USB charging port (on both sides)
4. 1-line row is On/Off, Hold, and Mute;
2-line (shown) row is Line 1, Hold/Conf, and Line 2
5. Dial pad
6. Volume s (increase), Volume t (decrease), FNC, and Redial keys
7. Charging Indicator

E100IP & E200IP Trimline Phone Map



BASE FEATURES AND CONTROLS

1. Handset
2. Handset Message Waiting/Ringing Indicator key
3. Base
4. 1-line phone: Hold, Redial, and Mute keys
2-line phone: Conference, Redial, and Mute keys
5. Dial pad
6. Volume s (increase) and Volume t (decrease) keys
7. 2-line phones have Line 1 plus LED, Line 2 plus LED, and Hold keys here

Quick Start

Cetis' next generation of SIP phones has several deployment options available through the network. All of them require the download and application of a configuration file with all the necessary parameters in place to navigate their network and register to a SIP PBX/server. The recommended method of starting is to use the provided tools to create uniform configuration files, as each phone endpoint does require a unique configuration file to operate correctly. The configuration file is the sum of all of the parameters found in the web interface of the phone and constitutes its complete programming information. By using the Mass Configuration utility tools, you can ensure that the substitution of values is not subject to human error that may happen when programming several hundred phones by hand.

The initial step in creating a template configuration file is to program the phone via web interface for your network and then export that file from within the web interface. To start programming the phone, power the phone with PoE into the WAN port of the phone. When you first hear the "doodle-doodle" configID tone you do not want to download a config file; instead, press # directly to enter into the default standby status. After the phone enters into the default standby status, press **47# (** | P #) on the keypad to make the phone recite and/or display its own IP address. With that IP address, you may log in and check the existing configuration or begin programming the phone through the web interface. Once programmed and tested in the local environment, export that config file and use it as a template configuration file in the Mass Configuration tool.

For Cloud-based systems installers, there is a new zero-touch method of deployment that employs a re-direction server, allowing the installer to simply place a phone on the network,

where the phone will attempt to reach an address of <https://provision.cetis.com> during its boot-up process. At that address, the installer will have an account with a list of their phones' valid MAC addresses, and an URL for another server where the phones' configuration files reside. The phone will then go to that re-directed address and download the configuration file of `<macaddress>.cetis.cfg` and apply it. The phone is then configured.

Alternatively, as the phone boots-up, it will by default be configured to enable LLDP and DHCP. This will help to navigate the network to the proper VLAN and obtain its IP address as well as the Provisioning Server's IP address through a DHCP Server (DHCP Options 60/43 or 66). The phone will either download its config file as `<macaddress>.cetis.cfg` or, if that file is not found, the phone will produce a audio prompt ("doodle-doodle") tone as well as flashing lights to prompt the user to enter a "Config ID".

After inputting the ConfigID through the numeric keyboard and ending with #, the phone will download the configuration file named `<ConfigID>.cetis.cfg` from the Provisioning Server. If the download is successful, the phone will apply the configuration and re-boot. If it failed—no file found or no server configured—the phone will boot with default settings.

Function

1. Support DHCP assigns IP address, etc., automatically
2. Support PPPoE (used while connecting ADSL, cable modem)
3. Firmware and configuration can be updated via HTTP, HTTPS, FTP, and TFTP
4. Hold function
5. Speed-dial
6. DND (Do not disturb), black list, hotline function

7. Voicemail message
8. Configurable via common browsers
9. Remote management function
10. Classification management for common user's password and super-user's password
11. Support **codes function
12. Call waiting
13. Auto answer
14. Call park
15. Call transfer
16. Three-way conference
17. 802.1x authentication
18. LLDP feature

Standards and Protocols

- IEEE 802.3 /802.3 u 10 Base T / 100Base TX
- PPPoE
- DHCP Client and Server
- Support G.711a/u,G729, G723.1 Audio Codec
- SIP RFC3261
- TCP/IP: Internet Transfer and Control Protocol
- RTP: Real-Time Transport Protocol
- VAD Save Bandwidth
- TFTP: Trivial File Transfer Protocol
- 802.3af POE

1. Introduction

This Cetus SIP endpoint device is SIP 2.0 compliant with RFC 3261, and some configuration is necessary before using the phone. The base is connected via networking cable and powered via 802.3af PoE (Power over Ethernet). If the endpoint is a cordless set, the handset is a DECT radio device that synchronizes to the base. If the set is a corded device, the handset coil cord is simply plugged into the proper port on the base. This manual will illustrate how to setup the phone through the keypad and web interface.

1.1 Overview of Hardware

1.1.1 BASE UNIT

The base unit has a WAN interface and LAN interface for a total of two network ports. The default WAN interface is a DHCP Client. The user will connect the WAN interface to a PoE switch to obtain power and an IP address, and connect the LAN interface to a computer to bridge the network or configure virtual LAN networks. The administrator username "admin" and password "admin" is used to login and configure the set via HTTP web browser access. Only the WAN interface supports 802.3af Power Over Ethernet. The LAN port can be setup to mirror the WAN port for diagnostic troubleshooting or disabled entirely.

1.1.2 DECT HANDSET

The DECT handset is automatically synchronized to the base and operates at 1.9 GHz in North America and 1.8 GHz in many parts of Europe. The handsets auto-negotiate with the base through the charging leads on the base/cradle for seamless, secure cordless communications. Setting the handset (with connected battery) into the cradle (when powered by PoE) will synchronize the handset to the base.

1.2 Overview of Software

1.2.1 CONFIGURATION METHODS

3.x firmware configuration and firmware updates can be controlled by:

- Using a web browser to setup configuration and update the firmware. Press the key strokes **47# (** I P) #, and the phone will announce its IP address from the audio speaker. Input this IP address directly into the browser address field to reach the login page of the phone. The default username/password is admin/admin.
- Downloading configuration files from a provisioning server. Create configuration file for the phone(s), and place it on the provisioning server. Ensure provisioning server is reachable by phone.

1.2.2 SPECS OVERVIEW

Network Protocol
<ul style="list-style-type: none"> • SIP v2(RFC3261) • IP/TCP/UDP/RTSP • IP/ICMP/ARP/RARP/SNTP • TFTP Client/DHCP Client/PPPOE Client • SSH/HTTP Server • DNS Clients
Codec
<ul style="list-style-type: none"> • G.711a • G.711u: • G.723.1: • G.729 • G.722
Voice Quality
<ul style="list-style-type: none"> • VAD: Voice Activity Detection • AGC: Automatic Gain Control • AEC: Automatic Echo Cancellation • SRTP: Secure Real-Time Transport Protocol
Call Function
<ul style="list-style-type: none"> • Call Hold • Call Forward • Call Waiting • Caller ID

DTMF
<ul style="list-style-type: none"> • IN Band • SIP Info • RFC2833
Tone
<ul style="list-style-type: none"> • Ring Tone • Dial Tone • Ring Back Tone • Busy Tone
Phone Function
<ul style="list-style-type: none"> • Volume Adjustment • Speed Dial Key
IP Assignment
<ul style="list-style-type: none"> • IP (Static IP) • DHCP • PPPoE
Security
<ul style="list-style-type: none"> • HTTP 1.1 Basic/Digest Authentication for Web Setup • MD5 for SIP Authentication (RFC2069/RFC2617) • SRTP/TLS for Secure Conversation • HTTPS for Secure Provisioning
QoS
<ul style="list-style-type: none"> • QoS Field
NAT Traversal
<ul style="list-style-type: none"> • STUN
Configuration
<ul style="list-style-type: none"> • Web Browser • Keypad • Via Config File
SIP Server
<ul style="list-style-type: none"> • Support two SIP servers working at the same time • Provide a backup SIP server
Firmware Upgrade
<ul style="list-style-type: none"> • TFTP • HTTP • HTTPS • FTP

1.3 Understanding Buttons and Hardware

You can use the tables that follow to identify the buttons and hardware on your phone.

Base Keys Functions

Keys	Mode	Function/Display
Volume +	Calling	Increase volume
	Config	Choose page (page up)
Volume -	Calling	Reduce volume
	Config	Choose page (page down)

Keys	Mode	Function/Display
Message	Dialing	Pick up the voicemail message
Line 1	Hook-on	Pick up
	Talking	Hold or resume
Line 2	Hook-on	Pick up
	Talking	Hold or resume
Page	Hook-on	Press to call handset; press this key for 3 s to register handset
Speaker	Talking	Between the handset and speaker switches
Mute	Talking	Mute function
Redial	Dialing	Redial the last number and make a call
Hold	Calling	Hold or resume or park key
M1~M7	Dialing	7 speed dial numbers or the second function
Menu	On-hook	Press this key to store number; press this for 3 s to enter the phone menu
	Config	Confirm/enter to the next sub-menu
Enter	Config	Exit /return to the first menu
1	Dialing	"1"
	Config	"1", "space", "@", "_", "-", "/", "%"
2	Dialing	"2"
	Config	"2", "a", "b", "c", "A", "B", "C"
3	Dialing	"3"
	Config	"3", "d", "e", "f", "D", "E", "F"
4	Dialing	"4"
	Config	"4", "g", "h", "l", "G", "H", "I"
5	Dialing	"5"
	Config	"5", "j", "k", "l", "J", "K", "L"

Keys	Mode	Function/Display
6	Dialing	"6"
	Config	"6", "m", "n", "o", "M", "N", "O"
7	Dialing	"7"
	Config	"7", "p", "q", "r", "s", "P", "Q", "R", "S"
8	Dialing	"8"
	Config	"8", "t", "u", "v", "T", "U", "V"
9	Dialing	"9"
	Config	"9", "w", "x", "y", "z", "W", "X", "Y", "Z"
0	Dialing	"0"
	Config	"0", "*", "#", "\$", "&", "?", "!", "<", ">"
*	Dialing	"*"
	Config	"*", "."
#	Dialing	Dial as the first number or finish number sign

Handset Keys Functions

Keys	Mode	Function/Display
Volume +	Talking	Increase receiver volume
	Hook-on	Increase ringer volume
Volume -	Talking	Reduce receiver volume
	Hook-on	Choose ringer volume
Line 1 ON/OFF	Hook-on	Pick up
	Talking	Hold or resume
Line 2 ON/OFF	Hook-on	Pick up
	Talking	Hold or resume
Redial	Dialing	Redial the last number and make a call
Hold/Conf	Calling	Hold or resume or conference
FNC	Talking	Call transfer
	Hook-on	Press for 5 s to adjust the incoming call ringer types, use the number keys 1-6 to choose ringer type

Keys	Mode	Function/Display
1	Dialing	"1" or press for 3 s to pick up voicemail message
	Config	"1", "space", "@", "_", "-", "/", "%"
2	Dialing	"2"
	Config	"2", "a", "b", "c", "A", "B", "C"
3	Dialing	"3"
	Config	"3", "d", "e", "f", "D", "E", "F"
4	Dialing	"4"
	Config	"4", "g", "h", "l", "G", "H", "I"
5	Dialing	"5"
	Config	"5", "j", "k", "l", "J", "K", "L"
6	Dialing	"6"
	Config	"6", "m", "n", "o", "M", "N", "O"
7	Dialing	"7"
	Config	"7", "p", "q", "r", "s", "P", "Q", "R", "S"
8	Dialing	"8"
	Config	"8", "t", "u", "v", "T", "U", "V"
9	Dialing	"9"
	Config	"9", "w", "x", "y", "z", "W", "X", "Y", "Z"
0	Dialing	"0"
	Config	"0", "*", "#", "\$", "&", "?", "!", "<", ">"
*	Dialing	**
	Config	*, .
#	Dialing	Dial as the first number or finish number sign

2. Operating Method for Dialing

2.1 How to Dial a Phone

You can place calls after the phone is successfully registered to a SIP server/IP-PBX. Please confirm that all cables for power and network connectivity are correct.

2.1.1 BASIC CALL

- Place a call using the handset:
Line 1/Line 2 is in off-hook status, dial a number, and then dial # as the ending character after the last digit to immediately send the digits to the SIP server.
- Place a call using the speakerphone:
The phone has an active keypad. That means pressing a number on the dial-pad will take Line 1 off-hook: dial the number and then dial # as the ending character after the last digit to immediately send the digits to the SIP server.

2.1.2 HOLD AND RESUME

- You can hold and resume calls. Only one call can be active at any given time on a corded phone; all other connected calls must be placed on hold. Two-line cordless phones can have up to two active conversations.

1) Put a call on hold

Make sure the call you want to put on Hold is enabled, then press the Hold key.

2) Resume a call from hold

Make sure the appropriate call is enabled, then press the Hold key or press the Line 1 or Line 2 key to resume the call on whichever line was on Hold.

- Call Park feature
Enable Call Park feature and the Hold key can be used as a Park key (see below).

2.1.3 VOLUME CONTROL

Press VOL+ to increase the volume and press VOL- to decrease.

2.1.4 MUTE

If you do not want the called party to hear your end of the line, press the Mute key; they will not hear your conversation or background noise. You will still hear their conversation. This is often used while in conference calls.

2.1.5 MULTI-FUNCTION MEMORY KEYS

The speed dial memory keys have multiple modes of operation. They may also be used as hold, DND, transfer, and conference functions. See the web settings of the call feature function.

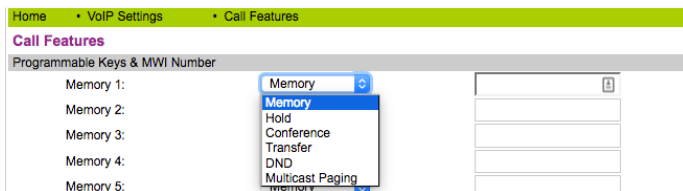

2.1.6 THREE-WAY CONVERSATION

If Line 1 is holding and Line 2 is talking on an active call, initiate a conference call by pressing the conference key connecting all three parties. When the phone is in three-way conference, the user cannot switch between base and handsets.

2.1.7 TRANSFER

The phone is capable of blind and attendant transfers. For example:

Blind Transfer—User A is conversing with user B. A wants to transfer the call conversation with B to user C. User A would press the Transfer key (a speed dial programmed with transfer function) and call user C. Press the Transfer key again to leave the call and finalize the transfer function to connect user B with user C.

Attended Transfer—User A is conversing with user B. A wants to transfer the call conversation with B to user C. User A would press the Transfer key (a speed dial programmed with transfer function) and call user C. After the call between user A and user C is connected, user A would hang up to leave the call and finalize the transfer function to connect user B with user C.

2.1.8 CALL PARK

The Hold key can be configured to utilize a Call Park function. Call Park is essentially sending an active call to a place holder on the server where someone else can then retrieve the call from its “parking spot.” Many PBXs have a Call Park and Call Retrieval special feature code.

Park is programmed in the phone under Call Features > Programmable Keys and MWI Number section. Set Park Mode: to Park | Hold Key Active: The parking place code or pilot number | Hold Key Idle: The retrieval from parking place code.

2.1.9 REDIAL

Press the Redial key to dial the last number called. By default, the last number dialed will be erased after 60 minutes to protect guest privacy. This time is configurable under Dialing Rules > Dialing Rules Configuration from 0~60.

2.1.10 REGISTER HANDSET

The handset on the IP DECT phone is essentially a radio, and can register to the base in two ways: manual registration and automatic registration.

Manual Registration: While on-hook, press the Page key on the base unit for three seconds to begin the handset registration mode. The Message indicator light will begin to flash. Press the * key for 3 seconds to register the handset, then you will hear a confirmation tone indicating a successful registration.

Automatic registration: Place the handset in the cradle of the base. The Message light begins to

flash, indicating the handset is in register mode; the ON/OFF light on the handset flashes at the same time. If the handset registers successfully to the base, then the Message light on the base and the ON/OFF light on the handset will stop flickering and will give the prompt tone for a successful registration.

Note: Each base phone can register up to 5 handsets.

2.1.11 DELETE HANDSET

Hold down the page key until the MWI light starts blinking, then release the page key and press it 7 times. After this the MWI light should start blinking rapidly. After the page light as stopped blinking rapidly, all handset registrations should be deleted.

2.1.12 SWITCH BETWEEN BASE AND HANDSET

When a call is active on the base phone, press the Line 1 or Line 2 handset key and the handset will pick up the active call. If a call is active on the handset, press the Line 1 or Line 2 key on the base to switch the conversation to the base.

2.1.13 SWITCH BETWEEN LINE 1 AND LINE 2

When Line 1 is on Hold and Line 2 is active, press the Line 1 key, and Line 1 will no longer be on Hold—Line 2 is now on Hold. If Line 2 is on Hold and Line 1 is active, press the Line 2 key for Line 2 to resume and for Line 1 to be placed on Hold.

2.1.14 BASE PHONE AND CORDLESS HANDSET CAN MAINTAIN INDEPENDENT CONVERSATIONS

The base phone and the cordless handset can maintain conversations independently, with true two-line functionality. For example, Line 1 can place a call from the base phone to one phone destination while Line 2 from the cordless handset can be active to a separate destination.

3. Web Interface Settings

Connect both the phone and your PC on the same LAN (Local Area Network), open the browser and enter the IP address of the phone. The browser will ask you to enter the username and password. Please enter the username and password as to login. Default username and password are admin/admin.

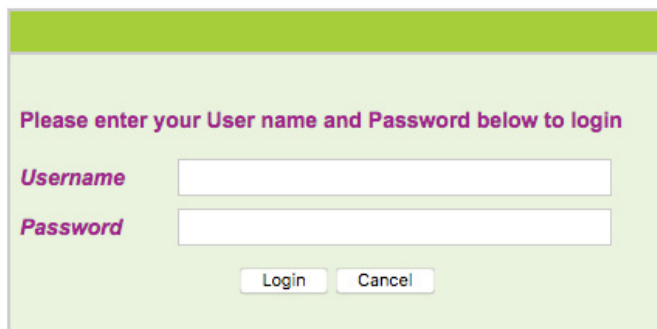

3.1 Home Page—Summary of Network Parameters

After entering the username and password, the following screen is displayed:

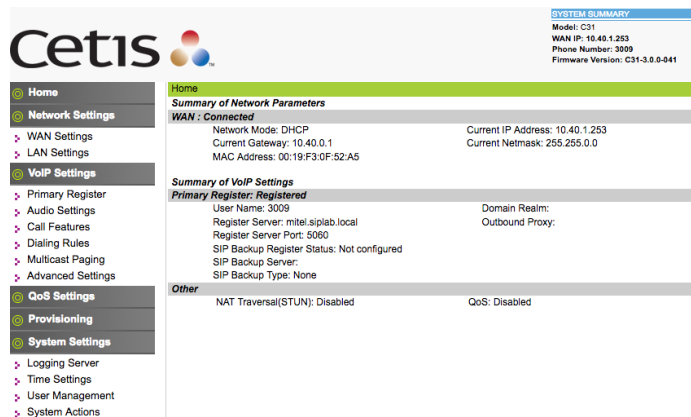

3.2 Network Settings

You can get your network information from this page:

Home • Network Settings

Network Settings

Summary of Network Parameters

WAN : Connected

Network Mode: DHCP	Current IP Address: 10.40.1.181
Current Gateway: 10.40.0.1	Current Netmask: 255.255.0.0
MAC Address: 00:19:F3:0F:51:B6	

3.2.1 WAN SETTINGS

WAN port network settings page can be used to configure network access settings. Some vendors call it the network port. This port is used to power (POE) and connect the phone to the network. Supports static IP, DHCP (to obtain dynamic IP address), and PPPoE.

Home • Network Settings • WAN Settings

WAN Settings

WAN Interface: Connected

Basic Settings

Network Mode: DHCP Fixed PPPoE

Link Mode:

Primary DNS:

Secondary DNS:

Static IP Settings (Required if Network Mode is set to Static IP)

Static IP Address:

Subnet Mask:

Default Gateway:

PPPoE Settings (Required if Network Mode is set to PPPoE)

User Account:

Password:

802.1X Settings

802.1X:

User Name:

Password:

Type:

LLDP Settings

LLDP:

Packet Interval:

3.2.2 BASIC SETTINGS

Basic Settings

Network Mode: DHCP Fixed PPPoE

Link Mode:

Primary DNS:

Secondary DNS:

Basic Setting

Network Mode	Select WAN port network mode. Default is DHCP.
Link Mode	Auto is default.
Primary DNS	Set the primary DNS IP address.
Secondary DNS	Set the secondary DNS IP address.

3.2.3 DHCP

If there is a DHCP server in your local network, the phone will automatically obtain WAN port network information from your DHCP server.

3.2.4 STATIC IP SETTINGS

If you wish to set the phone to a static IP address, configure the IP address, subnet mask, and gateway here. DNS servers configured under Basic Settings will be used.

Static IP Settings (Required if Network Mode is set to Static IP)

Static IP Address	<input type="text" value="192.168.1.100"/>
Subnet Mask	<input type="text" value="255.255.255.0"/>
Default Gateway	<input type="text" value="192.168.1.1"/>

Static IP Setting (Required if Network Mode Is Set to Static IP)

Static IP Address	Set static IP address.
Subnet Mask	Set network mask of static IP.
Default Gateway	Set default gateway IP address of static IP.

3.2.5 PPPOE SETTINGS (POINT TO POINT PROTOCOL OVER ETHERNET)

PPPoE Settings (Required if Network Mode is set to PPPoE)

User Account:

Password:

PPPoE Setting (Required if Network Mode Is Set to PPPoE)

User Account	Set your PPPoE user account.
Password	Set the password of your PPPoE account.

3.2.6 802.1X SETTINGS

802.1x Settings

802.1X Settings

802.1X:

User Name:

Password:

Type:

802.1x_Enable	Enable or disable 802.1x authentication.
802.1x_UserName	802.1x User name.

802.1x_Password	802.1x Authentication password.
802.1x_Type	Multicast (default) or Broadcast.

3.2.7 LLDP SETTINGS

LLDP Settings

LLDP Settings

LLDP

Packet Interval

LLDP Enable	Enable or disable LLDP feature.
Packet Interval	120 (default).

LLDP-MED (Link Layer Discovery Protocol-Media Endpoint Discovery) is a vendor-neutral link layer protocol in the Internet Protocol Suite used by network devices for advertising their identity, capabilities, and neighbors on an IEEE 802 local area network, principally wired Ethernet. LLDP-MED is enabled by default on the phone and is used to help the phone navigate to the correct VLAN. If properly configured on the L2 switch, the phone should arrive on the VLAN segment it is directed to. Once on the correct VLAN, the phone will try to obtain an IP address via DHCP.

3.2.8 LAN SETTINGS

The LAN port is used to provide network connectivity to guest ethernet devices such as laptops. It has several modes of operation:

- WAN/LAN Mirror—All WAN traffic is mirrored to the LAN port. This can be used for diagnostic troubleshooting of the phones connection by plugging in a capture device such as a laptop with Wireshark into the LAN port.
- Bridge—LAN traffic is passed-through the WAN port unaltered (unless QoS settings are specified, see appropriate section) to the access switch.
- NAT—The WAN port address is used to translate IP connections of devices that are connected to the WAN.

- Disable—LAN port can not be used to connect ethernet devices to the network.

Home • Network Settings • LAN Settings

LAN Settings

Link Mode

WAN/LAN Mirror Enable

LAN Port Mode NAT Bridge Disable

If NAT is selected/enabled, you may use the phone as a DHCP server as well. This is not a feature often used in the intended hotel guestroom setting. More often the LAN is left as bridge, and additional QoS/VLAN settings are applied to separate Data (LAN) and Voice (WAN) traffic. Please see QoS settings.

NAT

IP Address

Subnet Mask

DHCP Server

IP Pool Start

IP Pool End

MAX Leases (1~250 leases)

DNS Relay

3.3 VoIP Settings

You can get your SIP account information and registration status from this page.

Home • VoIP Settings

VoIP Summary

Primary Register: Registered

User Name: 3001 Domain Realm:
 Register Server: 10.40.0.40 Outbound Proxy:
 Register Server Port: 5060 Outbound Proxy Port:
 SIP Backup Register Status: None
 SIP Backup Server:
 SIP Backup Type: None

Other

NAT Traversal(STUN): Disabled STUN Server Address:

3.3.1 PRIMARY REGISTER

You set up your SIP account on this page. These are the minimum required variables to enable the phone on a SIP PBX server.

Home • VoIP Settings • Primary Register

Primary Register

Main Server: Registered Backup Server: Not configured

Register Server

Use Service

Display Name

User Name

Authorization User Name

Password

Register Server Port

Register Server Address

Domain Realm

Outbound proxy

Register Expire

SIP Backup Type

SIP Backup Server

Register

Register Server	
Use Service	Enable or disable this SIP account. Default is Disabled.
Display Name	Set display name of your SIP account.
User Name	Set user name (SIP account number).
Authorization User Name	Set authorization user name of your SIP account.
Password	Set password of your SIP account.
Register Server Port	Set register server's port number. Default is 5060.
Register Server Address	Set register server's IP address or domain name.
Domain Realm	Set server authentication realm.
Outbound Proxy	Set if your service provider has different proxy server from register server. Most of the service providers use the same address for both servers.
Register Expire	Set register expire time. The unit is a second. Default is 300.
SIP Backup Type	Set the operation of the Backup SIP server
SIP Backup Server	Set the IP address of the Backup SIP server

Protocol Control	
MWI Subscribe	Set Disable/Enable message waiting through pull-down menu, including: Disable: MWI is disabled, even if received NOTIFY message from the server indicating new voicemail, phone will not prompt. Enable (Subscribe): MWI is enabled and SUBSCRIBE will be sent, if the server sends NOTIFY message indicating new voicemail received, MWI LED will blink to prompt. Enable (No Subscribe): MWI is enabled, but phone will not send SUBSCRIBE, if the server sends NOTIFY message indicating new voicemail received, MWI LED will also blink to prompt.
Subscribe Expire	Set subscribe expire time. The unit is a second. Default is 300.
Local SIP Port	Set the port to send receive SIP packets (when transport is UDP). Default is 5060.
DTMF	Select DTMF mode. Choices can include RFC2833, In Band, and SIP Info. Default is RFC2833.
Anonymous Call Rejection	Set to reject anonymous calls. Default is OFF.
PRACK	Enable or disable PRACK.
Rport	Open or close the rport mechanism.
Transport	UDP/TCP transmission mode.

3.3.2 AUDIO SETTINGS

You can adjust sound and volume settings, set codecs and ring types and international signal standards on this page.

Home • VoIP Settings • Audio Settings

Audio Settings

Sound and Volume Control

Handset: 5 (1-7)
 Speaker: 2 (1-7)
 Ringer Tone: 5 (1-7)
 Signal Standard: United States
 Ringer: Off On
 Ringer Type: ringer 1

Codecs Settings

Codec Priority 1: G.711u
 Codec Priority 2: G.723.1
 Codec Priority 3: G.729
 Codec Priority 4: G.711a
 Codec Priority 5: iLBC
 Codec Priority 6: G.722
 Packet Data Size: 20 ms
 iLBC 15.2K: Off On
 G.723.1 5.3K: Off On

Voice VAD/CNG

VAD: Off On
 CNG: Off On

Codec ID Settings

RFC2833 ID: 101 (95-127)
 Apply Cancel

Audio Settings

Sound and Volume Control	
Handset	Set output volume of handset. Ranges from 1-7. Default is 5.
Speaker	Set output volume of speaker. Ranges from 1-7. Default is 5.
Ring Tone	Set volume of ring tone. Ranges from 1-5. Default is 5.
Ringer	Turn Ringer off or on.
Ringer Type	Select ringer type.
Codec Setting	
Codec #1-6:	Prioritize the codec selections, there are six choices: <ul style="list-style-type: none"> • G.711a • G.711u • G.729 • G.723.1 • G.722 • iLBC
Packet Data Size	Size of the RTP packet size. Default is 20 ms.
Voice VAD/CNG	
VAD	Enable or disable Voice Activated Detector function. VAD can reduce RTP data to not send silence packet. Default is Enabled.
CNG	Enable or disable Comfort Noise Generation when silence is detected in the conversation.

Codec ID Settings	
DTMF Payload (RFC2833)	Set the default DTMF payload ID.

3.3.3 CALL FEATURES

You can set call features, program Speed Dial button functions and Message Waiting Indication buttons, as well as create blocked and/or restricted lists on this page.

Home • VoIP Settings • Call Features

Call Features

Programmable Keys & MWI Number

Memory 1: Memory
 Memory 2: Memory
 Memory 3: Hold
 Memory 4: Conference
 Memory 5: Transfer
 Memory 6: DND
 Memory 7: Multicast Paging
 Memory 8: Memory
 Memory 9: Memory
 Memory 10: Memory
 MWI Number:
 Park Mode: Default
 Hold Key Active:
 Hold Key Idle:

Call Features

Hotline:
 Warm Line Time: 4 (0-30 sec)
 Auto Answer: Off On
 Auto Answer Time Out: 5 (0-30 sec)
 Forward Type: Disable
 Forward Number:
 Enable Call Time Out: Enable
 No Answer Time Out: 20
 Call Waiting: Off On
 Do Not Disturb: Off On
 Ban Outgoing: Off On
 Accept Any Call: Off On
 Apply Cancel

Blocked List Set

Position	Number	Select
1		<input type="checkbox"/>
2		<input type="checkbox"/>
3		<input type="checkbox"/>
4		<input type="checkbox"/>
5		<input type="checkbox"/>
6		<input type="checkbox"/>
7		<input type="checkbox"/>
8		<input type="checkbox"/>
9		<input type="checkbox"/>
10		<input type="checkbox"/>

Delete Selected Delete All Cancel

Add New

Position: (1-10)
 Number:
 Add Cancel

Call Features

Programmable Keys & MWI Number	
Mem1– Mem10	1. Input speed dial number. OR 2. Configure the second feature: Every memory key can be set as a feature key to hold, DND, transfer, or initiate a conference.
MWI Number	Input voice mail number.
Park Mode	Enable or disable the Call Park feature
Hold Key Active	Configure the number of the Park key. In Park mode, if a call is active on either line, press the Hold key to actively call the parking slot number. This is a feature to place a call into a parking slot on the PBX if the PBX is capable of that feature.
Hold Key Idle	Configure the number of the Park key. In Park mode, if no call is active and a line is available, execute Idle by pressing the Hold key. Hold will call the programmed number (usually to retrieve a call in a parked state).
Hotline Number	Program a hotline number for immediate dialing when off-hook.
Warm Line Time	Set waiting time for the user picking up the phone to dial hotline number. The range is 0–30 s; default is 4 s. If warm line time is 0 s, then hotline number will be sent right away after off-hook. If the range is 1–30 s and using 3 s as an example, the hotline number will be sent 3 s later automatically without pressing any key. As long as any key is pressed within that setting time, the timer will be suspended and the hotline call will fail.

Forward Type	Select the type of call forward: Default is Disable. Disable: Disable call forward. All Forward: The caller is always forwarded to the appointed phone. Busy Forward: If the phone is busy, it will forward to the appointed phone. No Answer Forward: If no answer, it will forward to the appointed phone.
Forward Number	Call the forwarded phone number.
Enable Call Time Out	Enable or disable no answer time out. Default is enabled.
No Answer Time Out	No answer call forward time setting. Default value is 20 s.
Call Waiting	Enable/disable Call Waiting.
Do Not Disturb	Enable this option to refuse any calls.
Ban Outgoing	Enable or disable outgoing calls. Default is OFF.

In the Blocked List section of the web page, click ADD to add a blacklisted number from which you do not want to receive calls:

The screenshot shows a web interface for managing a blocked list. At the top, it says "Blocked List Set". Below that is a table with three columns: "Position", "Number", and "Select". The "Position" column has numbers 1 through 10. The "Number" column is currently empty. The "Select" column has checkboxes next to each position. Below the table, there are three buttons: "Delete Selected", "Delete All", and "Cancel". Below that is a section titled "Add New". It has a "Position:" label with a dropdown menu showing "(1-10)". Below that is a "Number:" label with an input field. At the bottom of this section are "Add" and "Cancel" buttons.

3.3.4 DIALING RULES

You can manage your dial rules on this page. You can remove the option of sending digits

immediately by pressing the # key. It is also possible to set the timeout from when the user stops dialing until the digits transmit to the server (between 1 and 9 seconds).

Digital Map Configuration

Field Name	Description
Dialing Rules Configuration	Set dial ending rule. There are three kind of rules: <ul style="list-style-type: none"> • End with “#”. • Erase Redial memory (default is 60 s)—This is a guestroom security feature. • Auto Dial time is a timeout: Set dial ending waiting time in seconds. The default timeout is 5 seconds.
User Defined Rules	Define your dial ending rule by prefix number and length. In the example shown: 3xxx will cause every 4 digit number dialed, starting with a 3 to immediately dial without the 5 second timeout. So dialing 3004 would immediately send those digits to the SIP PBX and dial without a delay.

3.3.5 MULTICAST PAGING

Multicast paging allows the phone to receive paging as defined in the listening address from an audio source on the network and is a useful safety feature in case of emergencies or for non-safety related notifications.

3.3.6 ADVANCED SETTINGS

You can set NAT (Network Address Translation) traversal function on this page.

Advanced Setting

Field Name	Description
Enable	Enable or disable NAT (Network Address Translation) Traversal function. Default is disabled.
STUN Server Address	Set STUN server’s IP address.
STUN Server Port	Set STUN server’s port number.
Check Interval	Set check interval time. The unit is second.

3.4 QoS Settings (Quality of Service)/Virtual LAN (VLAN)

You can get your QoS Virtual LAN information from this page and configure voice and data VLANs.

QoS Setting

Field Name	Decription
Voice VLAN	Enable voice VLAN. Default is Off.
Voice VID Tag	VLAN tagging values (2~4094) available. Default is undefined number.
User Priority	Values (0 to 7) are available. Default is undefined.
Data VLAN	Enable data VLAN. Default is Off.
Data VID Tag	VLAN tagging values (2~4094) available. Default is undefined number.
User Priority	Values (0 to 7) are available. Default is undefined.
Voice QoS DiffServ	Set DSCP value. Default is 40.
SIP QoS DiffServ	Set DSCP value. Default is 40.

Regarding QoS and VLAN ID. In order to troubleshoot VLANs, you may use the QuickKeys from the dial pad of:

VL—**85# Show the VLAN ID.

VS—**87* <kp> * <vlan id> #.

Set the VLAN ID. Use value of 0 to turn off/disable VLAN. Example: * * 8 7 * 1 2 3 * 0 # will disable VLAN and should allow the phone to receive a

DHCP address from the local network segment. Any other valid number for a VLAN ID (2-4095) will set the VLAN ID to that number.

3.5 Provisioning

Provisioning is the methodology of getting the phone programmed with its necessary configuration file and/or upgrading firmware.

3.5.1 PROVISIONING OPTIONS

Provisioning Options

Field Name	Decription
DHCP Options	DHCP Options (such as 66, 60 and 43) will be checked in order to find a TFTP or other provisioning server.
Auto Redirection	The phone will contact https://provision.cetis.com to see if there is a provisioning server to be re-directed to for configuration file download.

Field Name	Decription
MAC File	Phone will request a configuration file of <macaddress>.cetis.cfg filetype. (It will automatically request its own internal MAC address.)
ConfigID	Phone will request a configuration file of <ConfigID>.cetis.cfg filetype. This is often used by the installer to input the config file name for retrieval. NOTE: This can/should be disabled in your production config files if it is not used in order to avoid the “doodle-doodle” config prompt tone that indicates the phone needs to be programmed. This tone will sound after every reboot if left ON and there is not a name in the ConfigID field under AutoUpdate Settings. This could disturb guests.
Firmware Update	The phone will automatically check the provisioning server for a file named firmware.cetis.txt. If found, it will compare its existing model and firmware to the firmware files listed in the .txt file and upgrade or downgrade as directed. Example: File firmware.cetis.txt #Place all firmware filenames that are required for installation on separate lines. Example: CM1-3.0.0-016.bin CC2-3.0.0-016.bin CE2-3.0.0-016.bin CE1-3.0.0-016.bin CM1-3.0.0-016.bin CM2-3.0.0-018.bin CD2-3.0.0-016.bin

Field Name	Decription
Notify/ Reboot Auth	SIP employs NOTIFY methods for things like Message Waiting Indication (MWI), but also can cause a SIP device to reboot. There is a setting to disable, require No Authentication, or require authentication before accepting the Notify. Require authentication does not affect NOTIFY used for voicemail.

3.5.2 PROVISIONING SERVER SETTINGS

In many cases the phone is informed which server to use via the DHCP proces or the re-direct server, and as such is left disabled by default. However, the user can manually program the provisioning server types of TFTP, FTP, HTTP, or HTTPS instead. Only FTP requires User Name and Password.

3.5.3 AUTOUPDATE SETTINGS

Updating configurations and firmware can be programmed to occur during a particular hour of each day. The ConfigID field would be expressed as the number. **Example:** 3001.cetis.cfg would be expressed as 3001. The filetype and suffix of cetis.cfg are already presumed by the phone. NOTE: It is good practice to always have the ConfigID number field populated, as it will also serve to disable the “doodle-doodle” config prompt tone that indicates the phone needs to be programmed. This tone will sound after every reboot if left ON and could disturb guests.

3.5.4 WEBUI MANAGEMENT

In this section you may:

- View what configuration file version number is loaded on the phone.
- Export the configuration file that is loaded on the phone.
- Import a new configuration file version onto the phone.
- View what firmware version number is loaded on the phone.
- Import a new firmware version onto the phone.

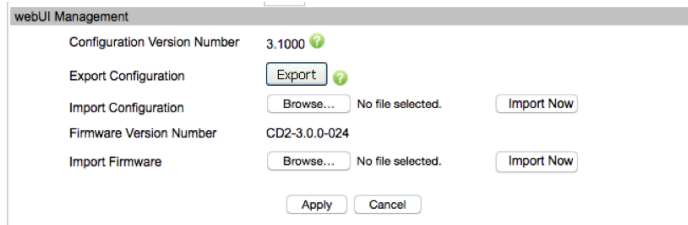

3.6 System Settings

The phone’s system information (logging server, time settings, user management, system actions, and DECT settings (in case of cordless radio handsets) are set on these pages.

3.6.1 LOGGING SERVER

Configure the Logging Server on this page.

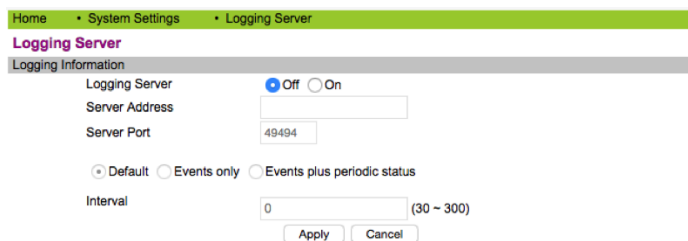

Logging Server

Field Name	Description
Logging Server	Enable or disable system log function. Default is disabled.
Server Address	Set system log server’s IP address or domain name.
Server Port	Set system log server’s port number. Default port is 49494, but is User Definable.

Field Name	Description
Events Only	Capture only significant events (e.g., Registration Lost or IP address change or Reboot requested).
Events Plus Periodic Status	Capture events as well as a periodic status (as defined in the Interval—Status update, e.g., Registered, Unregistered, Trying).
Interval	Interval from 30 seconds to 300 seconds to send information to the syslog server.

3.6.2 TIME SETTINGS

Time settings such as Daylight Savings Time and SNTP (Simple Network Time Protocol) servers are configured on this page.

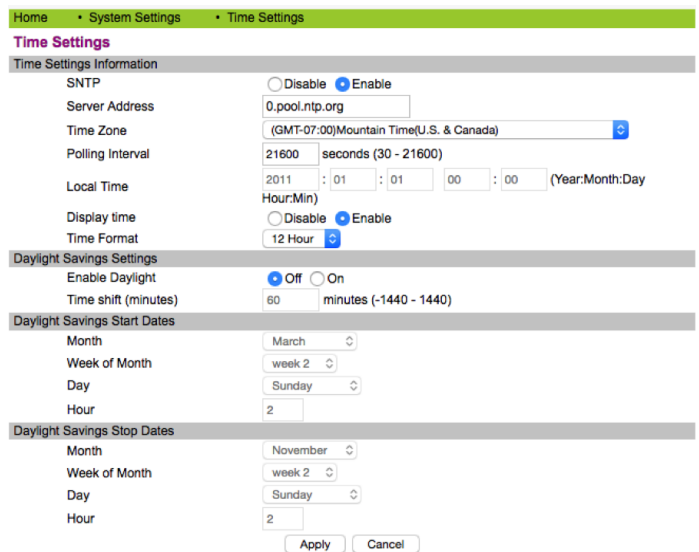

Time Settings

SNTP (Simple Network Time Protocol)—Enabled by Default	
Server Address	0.pool.ntp.org by default.
Time Zone	Select from GMT (Greenwich Median Time + or -).
Polling Interval	SNTP server polling interval in seconds.
Local Time	Manually configure time when SNTP is disabled.

Display Time	Enabled (by default) or Disabled (for phones with LCD screen only).
Time Format	12 hour or 24 hour (military) time display.
Daylight Savings Time	
Enable DST	OFF by default.
Time Shift	Almost always 60 minutes.
DST Start Date	Set when DST should start.
DST Stop Date	Set when DST should stop.

3.6.3 USER MANAGEMENT

Configure users' privileges and authentication on this page.

User Management

Keypad Password	
Keypad Password	Set the password of keypad. Default is 123.
Verify Password	Enter the new keypad password again for verification.
User Management	
Administrator User ID	Set the username of administrator mode. Default is "admin."
Administrator Password	Set the password of administrator mode. Default is "admin."
Verify Password	Enter the new password of administrator mode again for verification.

Remote Administration	
CetisAdmin User	Set the username of CetisAdmin account. Default is "admin."
CetisAdmin Password	Set the password of CetisAdmin account. Default is "admin."
Verify Password	Enter the new password of guest mode again for verification.

3.6.4 SYSTEM ACTIONS

Reset to factory default or reboot device is currently done on this System Actions page.

System Actions	
Reset to Factory Default	Click Reset button to restore all the settings to factory default.
Reboot Device	Click Reboot button to reboot the phone.

3.6.5 DECT—DIGITAL ENHANCED CORDLESS TELECOMMUNICATIONS

DECT cordless technology is used in Cetis SIP phones and both Power levels and Country codes can be changed in the web UI and the configuration file. There is also a line sharing feature, allowing a second person to share the line from another cordless handset. This can be disabled entirely, set to enabled to toggle the primary handset, or enabled to exclude the secondary handset.

Additionally, the FNC key on the handset can be programmed as Transfer, HOLD or MUTE.

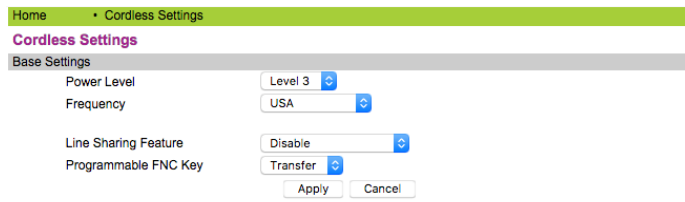

DECT Settings	
Power Level	Set the power level of the DECT signal. Default power level is 3. Weakest power level is 0 and strongest is 7.
Frequency	Each country has a different set of frequencies they allow within their spectrum. The drop-downs available set the allowable frequency codes for that country.
Line Sharing Feature	The line sharing feature, allows a second person to share the line from another cordless handset. This can be disabled entirely, for no line-sharing of handset or set to (Enabled—Toggle Itself) whereby the handset (itself) can enter or leave the call by pressing Line 1, or set to (Enabled—Cancel Other) to exclude the other handset when one handset presses Line 1, thus kicking the other handset off the call as a privacy mode. (Default mode is Disabled.)
Programmable FNC Key	The FNC key on the cordless handset can be set in this menu to act as transfer, hold, or mute on that handset.

4. Tech Notes

4.1 LLDP—Tech Notes

WHAT IS LLDP?

LLDP (Link Layer Discover Protocol) is a standardized protocol for advertising the identity and abilities of a device. It is useful for keeping inventory of connected devices. It can also be extended to advertise power requirements, VLAN information, etc., using LLDP-MED extensions.

Cetis phones can use LLDP information for VLAN provisioning, enabling the phone to be placed on the right network for configuration provisioning without manually configuring the phone.

HOW IS IT SET-UP?

Setting LLDP up is as simple as leaving the default settings in place on the Cetis phone. However, the POE switch must have LLDP turned on and be configured to use LLDP-MED for VLAN information for the phone to receive LLDP.

To change the interval LLDP packets are sent at, and to disable LLDP: The interval at which LLDP sends packets can be altered from 1–3600 seconds:

1. Log into phone’s webUI.
2. Go to Network Settings > WAN Settings.
3. Under LLDP Settings
 - a. Enable/Disable LLDP.
 - b. Change Packet Interval to a value from 1–3600.
4. Apply settings at bottom.
5. Press reboot prompt and/or unplug phone.

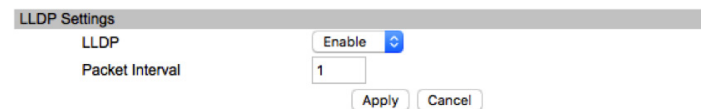

TROUBLESHOOTING

If the switch has been configured to advertise a voice VLAN, confirm the phone has configured itself by pressing ****85#** to hear/see the VLAN ID of the phone. If it is incorrect check your switch configuration. If it is correct, but the phone is not connecting then LLDP is not the issue, but IP connectivity. Check DHCP configuration.

4.2 802.1x—Tech Notes

WHAT IS 802.1X?

802.1x is an access control method for network devices. It helps protect the network from unauthorized devices connecting to the network by first requiring them to authenticate. There are several methods that the 802.1x standard supports to authenticate; however, our phones only support md5 authentication.

PROCESS

The supplicant (Cetis phone) connects to the authenticator (POE switch) which challenges the supplicant for credentials. Once these credentials are acquired the authenticator sends them to the authentication server. The authentication server can then send a success or failure message to the authenticator. Once the authenticator gets this response it either blocks the port or lets the device on the network. Afterwards VLAN configuration can be performed to place the phone on the right VLAN. This can be done by the switch, static phone configuration, or LLDP-MED.

HOW IS IT SET-UP?

Before 802.1x can be made to work, the authenticator (switch) and authentication server settings must be correct. Configuration of our phones to support 802.1x is very simple:

1. Log into phone's webUI.
2. Go to Network Settings > WAN Settings.

3. Under 802.1X Settings
 - a. Enable 802.1x.
 - b. Fill in User Name.
 - c. Fill in Password.
4. Apply settings at bottom.
5. Press reboot prompt and/or unplug phone and plug it into 802.1x switch.

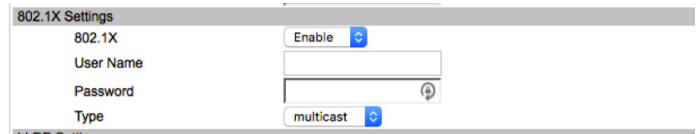

4.3 DHCP Options—Tech Notes

WHAT ARE DHCP OPTIONS?

DHCP is known for IP address configuration; however, it can configure much more via options. These options can tell the endpoint provisioning servers, VLAN info, DNS info, etc.

Endpoints send the options they support when they make a DHCP request, and the DHCP server responds with the correct information (if it is configured on the DHCP server).

OPTIONS SUPPORTED

Cetis phones support many options that make configuration more easily done.

Option 60/43—This is a vendor specific option. The Cetis phone sends option 60 containing a vendor class identifier. The DHCP server responds with option 43, which contains a string with configuration parameters.

Option 66—Option that identifies the TFTP server.

Option 1, 3, 6, 12, 15, 28, 40, 41—Used to provide common network information

Option 132—Vendor specified (common usage for VLAN ID in VoIP). Used to provide a VLAN ID to the phone.

Option 133—Vendor-specified (common usage for VLAN DSCP in VoIP). Used to provide VLAN QOS priority information to the phone (values 1-7).

HOW IS IT SET-UP?

DHCP Options are automatically requested at default and when DHCP is selected to be used as Network Mode:



Some DHCP options can be disabled by going to Provisioning and selecting Disable under Provisioning Settings:

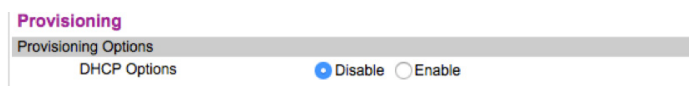

Cetis phones will request options 60/43, 66, 43, 132, and 133 even with a static IP address (via DHCP Inform). To disable DHCP completely, you will need to use a static IP address and disable DHCP Options in Provisioning. This turns off DHCP Inform; however, DHCP Inform is useful for duplicate address detection/prevention if a DHCP server is used on the same network.

DHCP Options will take precedence over static settings for most provisioning options. However, VLAN settings will be initially the static value as the initial DHCP request will be made on this VLAN.

TROUBLESHOOTING

The first step is to see the state of the phone by pressing ****47#**. If the IP address heard is on the same scope as set up in the DHCP server then look into option misconfiguration on the DHCP server. The DHCP server could be encoding the options in a way that the phone does not understand.

If a different IP address is heard or no IP address, then several problems could be at work:

1. Either no IP or wrong IP—The access port is configured to only accept tagged VLANs. To fix this you can use LLDP or ****87*123*<vlanID>#** to place the phone on a VLAN that can get DHCP information.

2. No IP—There is no DHCP server on the untagged network of the access port. Check DHCP configuration.
3. No IP—VLAN configuration was correct but there is a DHCP server misconfiguration. Check that the phone has the right VLAN by pressing ****85#**.
4. Wrong address—The phone connects to a DHCP scope, but the scope is on the untagged access network, and does not have the correct VLAN options configured to put the phone on the voice network. To fix this you can use LLDP, option 132, or statically with ****87*123*<vlanID>**.

4.4 QuickKey DialPad Shortcuts

A number of Quick Key commands have been implemented for ease of maintenance, administration and troubleshooting.

Each has a mnemonic which should make it easier to remember. In some cases, the command should be protected so the keypad password must be entered or the command will not be executed. In the descriptions below, the default keypad password **<123>** is represented as **<kp>**.

1. ****47#**, (**** IP #**) announces the phone's current IP address.
2. ****39#**, (**** FW #**) announces the phone's current software release number.
3. ****85#**, (**** VL #**) broadcasts the telephone current VLAN ID.
4. ****83#**, (**** TF #**) broadcasts the current TFTP server address.
5. ****72#**, (**** RB #**) reboots the phone.
6. ****36#**, (**** DN #**) broadcasts the current DN/extension number.
7. ****37#**, (****DS #**) toggles Daylight Savings ON/OFF to increase time display by 1 hour.

8. ****33*password#**, (**** DE*123 #**) clears the phone current configuration, resets to default settings, and reboots automatically.
9. ****77*password*config ID#**, the phone downloads a new specified configuration file from the TFTP server. After downloading successfully, ignoring the config file version number, the phone will restart automatically.
10. ****87*password*VLANID#**, (**** VS*123*newVLAN #**) revises the phone's VLAN ID. After revising the VLAN ID successfully, it announces the new VLAN ID and restarts the phone.
Example: Set the VLAN ID. Use value of 0 to turn off/disable VLAN.
Example: **** 8 7 * 1 2 3 * 0 #** will disable VLAN and should allow the phone to receive a DHCP address from the local network segment. Any other valid number for a VLAN ID (1-4095) will set the VLAN ID to that number.
11. ****89*<keypad password>*<TFTP server IP address>*<ConfigID>#**,
Example: ****89*<123>*<10 * 0 * 0 * 100>*<ConfigID>#**,
The phone downloads the specified configuration file <ConfigID> from the TFTP server at specified IP address (10.0.0.100). After downloading successfully, the phone will apply the file and restart automatically.

Important Safety Instructions

When using your telephone equipment, basic safety precautions should always be followed to reduce the risk of fire, electric shock, and injury to persons, including the following:

1. Read and understand all instructions.
2. Follow all warnings and instructions marked on the product.
3. Unplug the product from the wall outlet before cleaning. Do not use liquid cleaner or aerosol cleaners. Use a damp cloth for cleaning.
4. Do not use this product near water—for example, near a bathtub, wash bowl, kitchen sink or laundry tub, in a wet basement, or near a swimming pool.
5. Do not place this product on an unstable cart, stand, or table. The product may fall, causing serious damage to the product.
6. Slots and openings in the cabinet and the back or bottom are provided for ventilation, to protect it from overheating. These openings must not be blocked or covered. The openings should never be blocked by placing the product on the bed, sofa, rug, or any other similar surface. This product should never be placed near or over a radiator or heat register. This product should not be placed in a built-in installation unless proper ventilation is provided.
7. Never push objects of any kind into this product through cabinet slots as they may touch dangerous voltage points or short out parts that could result in a risk of fire or electric shock. Never spill liquid of any kind on the product.
8. To reduce the risk of electric shock do not disassemble this product. Take it to a qualified service facility if service or repair work is required. Opening or removing covers may expose you to dangerous

voltages or other risks. Incorrect reassembly can cause electric shock when the appliance is subsequently used.

9. Unplug this product from the wall outlet and refer servicing to qualified service personnel under the following conditions:
 - When the power supply cord or plug is damaged or frayed.
 - If liquid has been spilled into the product.
 - If the product has been exposed to rain or water.
 - If the product does not operate normally by following the operating instructions. Adjust only those controls that are covered by the operating instructions, as improper adjustment of other controls may result in damage and may require extensive work by a qualified technician to restore the product to normal operation.
 - If the product has been dropped or the cabinet has been damaged.
 - If the product exhibits a distinct change in performance.
10. Avoid using a telephone (other than a cordless type) during an electrical storm. There may be a remote risk of electric shock from lightning.
11. Do not use the telephone to report a gas leak in the vicinity of the leak.

PLEASE SAVE THESE INSTRUCTIONS.

FCC Interference Information

This device complies with Part 15 of the FCC Rules. Operation is subject to the following two conditions:

1. This device may not cause harmful interference.
2. This device must accept any interference received, including interference that may cause undesired operation.

This equipment has been tested and found to comply with the limits for a Class B digital device, pursuant to Part 15 of the FCC Rules. These limits are designed to provide reasonable protection against harmful interference in a residential installation. This equipment generates, uses, and can radiate radio frequency energy and, if not installed and used in accordance with the instructions, may cause harmful interference to radio communications. However, there is no guarantee that interference will not occur in a particular installation.

If this equipment does cause harmful interference to radio or television reception, which can be determined by turning the equipment off and on, the user is encouraged to try to correct the interference by one or more of the following measures:

- Reorient or relocate the receiving antenna for the radio or television that is receiving the interference).
- Reorient or relocate and increase the separation between the telecommunications equipment and receiving antenna.
- Connect the telecommunications equipment into an outlet on a circuit different from that to which the receiving antenna is connected.

FCC RF Radiation Exposure Statement

The installation of the base unit should allow at least 20 centimeters between the base and persons to be in compliance with FCC RF exposure guidelines. For body-worn operation, the portable part (handset) has been tested and meets FCC RF exposure guidelines.

This device must not be co-located or operating in conjunction with any other antenna or transmitter. The changes or modifications not expressly approved by the party responsible for compliance could void the user's authority to operate the equipment.

Industry of Canada Requirements

Note: This equipment meets the applicable Industry Canada Terminal Equipment Technical Specifications. This is confirmed by the registration number. The abbreviation, IC, before the registration number signifies that registration was performed based on a Declaration of Conformity indicating that Industry Canada technical specifications were met. It does not imply that Industry Canada approved the equipment.

Before installing this equipment, users should ensure that it is permissible to be connected to the facilities of the local telecommunications company. The equipment must also be installed using an acceptable method of connection. The customer should be aware that compliance with the above conditions may not prevent degradation of service in some situations.

Repairs to certified equipment should be coordinated by a representative designated by the supplier. Any repairs or alterations made by a user to this equipment, or equipment malfunctions, may give the telephone communications company cause to request the user to disconnect the equipment.

Users should ensure for their own protection, that the electrical ground connections of the power utility, telephone lines, and internal metallic water pipe system, if present, are connected together. This precaution may be particularly important in rural areas.

Caution: Users should not attempt to make such connections themselves, but should contact the appropriate electric inspection authority, or electrician, as appropriate.

Notice: The Ringer Equivalence Number (REN) assigned to each terminal device provides an indication of the maximum number of terminals allowed to be connected to a telephone interface. The termination on an interface may consist

of any combination of devices subject only to the requirement that the sum of the Ringer Equivalence Numbers of all the devices does not exceed 5.

REN: Z

For warranty and service in Canada, please contact:

Williams Telecommunications
5610 Kennedy Road
Mississauga, Ontario, L4Z2A9
Canada
Phone: 905-712-4242
Fax: 905-712-1754

Requirements of Part 15— FCC Rules

Note: This equipment has been tested and found to comply with the limits for a Class B digital device, pursuant to Part 15 of the FCC Rules. These limits are designed to provide reasonable protection against harmful interference in a residential installation. This equipment generates, uses, and can radiate radio frequency energy and, if not installed and used in accordance with the instructions, may cause harmful interference to radio communications. However, there is no guarantee that interference will not occur in a particular installation. If this equipment does cause harmful interference to radio or television reception, which can be determined by turning the equipment off and on, the user is encouraged to try to correct the interference by one or more of the following measures:

1. Move the telephone away from the receiver.
2. Consult the dealer or an experienced radio/TV technician for help.

Any changes made by the user not approved by the manufacturer can void the user's authority to operate the telephone.

Requirements of Part 68— FCC Rules

This equipment complies with Part 68 of the FCC Rules and the requirements adopted by ACTA. On the bottom of this telephone is a label that contains, among other information, a product identifier in the format US:AAAEQ##TXXXX. If requested, this number must be provided to the telephone company. The USOC Jack for this equipment is RJ11C.

A plug and jack used to connect this equipment to the premises wiring and telephone network must comply with the applicable FCC Part 68 rules and requirements adopted by ACTA. A compliant telephone cord and modular plug are provided with this telephone. It is designed to be connected to a compatible modular jack that is also compliant. See installation instructions for details.

The Ringer Equivalence Number (REN) is used to determine the number of devices that may be connected to a telephone line. Excessive RENs on a telephone line may result in the devices not ringing in response to an incoming call. In most but not all areas, the sum of RENs should not exceed five (5.0). To be certain of the number of devices that may be connected to a line, as determined by the total RENs, contact the local telephone company. For products approved after July 23, 2001, the REN for this product is a part of the product identifier that has the format US:AAAEQ##TXXXX. The digits represented by ## are the REN without a decimal point (e.g., 03 is a REN of 0.3). For earlier products, the REN is separately shown on the label.

If this telephone causes harm to the telephone network, the telephone company will notify you in advance that temporary discontinuance of service may be required. But if advance notice is not practical, the telephone company will notify

the customer as soon as possible. Also, you will be advised of your right to file a complaint with the FCC if you believe it is necessary.

The telephone company may make changes in its facilities, equipment, operations, or procedures that could affect the operation of the equipment. If this happens, the telephone company will provide advance notice in order for you to make the necessary modifications to maintain uninterrupted service.

If trouble is experienced with this equipment, for repair or warranty information, please contact Teledex at (800) 462-9446. If the equipment is causing harm to the telephone network, the telephone company may request that you disconnect the equipment until the problem is resolved.

There are no user-serviceable parts contained in this equipment.

Connection to party line service is subject to state tariffs. Contact the state public utility commission, public service commission, or corporation commission for information.

If your home has specially wired alarm equipment connected to the telephone line, ensure the installation of this product does not disable your alarm equipment. If you have questions about what will disable alarm equipment, consult your telephone company or a qualified installer.

This telephone is hearing aid compatible.

These telephone devices are intended for commercial use only, primarily in hotel guestrooms. They must be used with a PBX (private branch

exchange), and are not intended to be connected directly to a PSTN line (public switched telephone network). There are no user-serviceable parts inside the equipment.

Technical Specifications

DIMENSIONS

4.5" (w) x 8" (l) x 3.63" (h)

WEIGHT

With handset: 2.0 lbs.

POWER ADAPTER

7.5VDC 300mA Adapter (for cordless HDKIT)

9 VDC 300mA (Pass through adapter for cordless telephone)

User Guides

If additional User Guides are needed, please go to www.teledex.com to download the PDF.

Service

When problems arise that cannot be resolved using this or related documents, please go to www.teledex.com/support for information about customer support, technical support, warranty, and product returns.

Statement of Limited Warranty

Teledex product warranty information is available at www.teledex.com.



Toll Free: +1.800.462.9446

Tel: +1.719.638.8821

Email: info@teledex.com

www.teledex.com